

2.54*2.54(0.100"*0.100) EJECTOT HEADER,STRAIGHT

REVISION DATA			
ITEM	DESCRIPTION	DATE	REMARK
A			
B			
C			

SPECIFICATIONS 规格

CURRENT RATING 电流额定值 : 3AMP
 CONTACT RESISTANCE 接触电阻值 : 20mΩ Max
 INSULATION RESISTANCE 绝缘电阻值 : 1000MΩ Min
 DIELECTRIC WITHSTAND 耐压值 : 500V AC/minute
 OPERATION TEMPERATURE 工作温度 : -40°Cto+105°C

CONTACT MATERIAL 端子材质 : BRASS
 HOUSING MATERIAL 塑胶材质 :
 STANDARD 标准物料 : PBT + 30%G.F. ; UL 94V-0

OPTIONS 可选物料 : PA6T + 30%G.F. ; UL 94V-0
 PLATING 电镀 : Au or Sn Over 30u" Ni

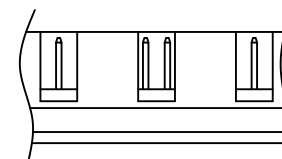
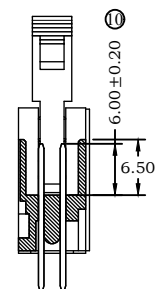
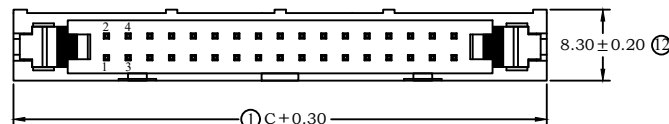
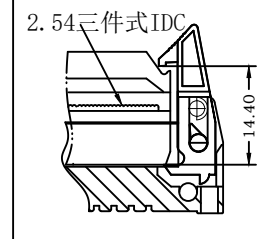

注: 60P和64P产品中间有三个缺口, 其余PIN位中间为一个缺口.

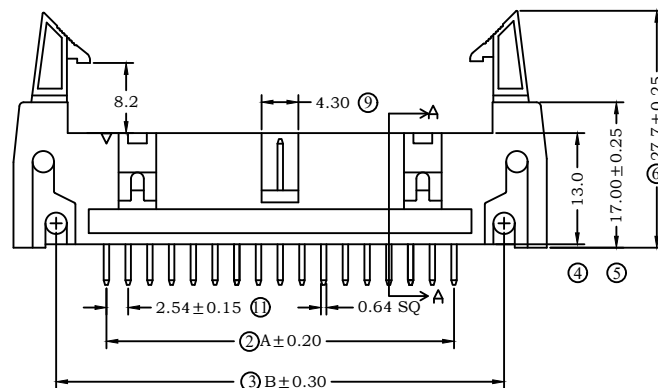

SECTION A-A

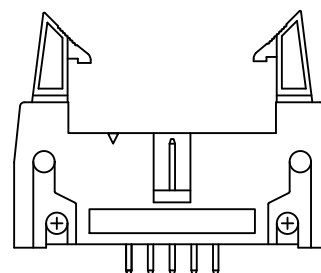
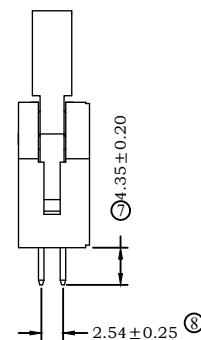

注: 10P-18P产品缺口两侧为平面

Ordering Information

EAS1701 - XX XX A XX X X B X

No. of Pins: 10~64
 Contact Plating: 01=Gold Flash, 04=Tin, Duplex Plating, 06=Gold Flash/Tin(100u")
 Housing Material: A=PBT, B=PA6T
 Packing: A=BAG, B=TRAY, C=TUBE, D=TAPE REEL

No. of PINS	Dimension Information		
	A	B	C
10	10.16	21.70	31.90
12	12.70	24.24	34.44
14	15.24	26.78	36.98
16	17.78	29.32	39.52
18	20.32	31.86	42.06
20	22.86	34.40	44.60
22	25.40	36.94	47.14
24	27.94	39.48	49.68
26	30.48	42.02	52.22
30	35.56	47.10	57.30
34	40.64	52.18	62.38
40	48.26	59.80	70.00
44	53.34	64.88	75.08
50	60.96	72.50	82.70
60	73.66	85.20	95.40
64	78.74	90.28	100.48

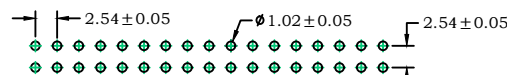

Recommended PCB Layout (Tolerance: ±0.05)

序号	材料	材质	料号	数量	备注
1	塑胶	PBT/PA6T	EA170-XXAX	1PCS	黑色
2	端子	H65	G064-171XXB	由塑胶决定	0.64*17.05
3	耳扣	PBT/PA6T	EQ254-1A	2PCS	长耳扣 黑色

J&C东莞市骏佳电子科技有限公司 JunJia Electronics Technology Co.,Ltd	绘图(Drawn by)	刘应涛	投影(Third angle projection)		公差 (Tolerance)	料号 (Part No)	EAS1701-XXXXAXX	页次 (Page)	1/1
	审核(Checked by)		单位(Unit)	MM	0.0 ±0.30 0.00 ±0.20	图号 (Draw No)	EAS1701-AXXAXB1/1		
	核准(Approved by)		比例(Scale)	1:1		品名 (Name)	2.54 牛角 180度 长耳		
			版本(Version)	A					
		日期(Date)	2022.03.08						